



## Gruppe 14

### Fittings

Messing - Galvanisert

AISI 316 -Pneumatikk

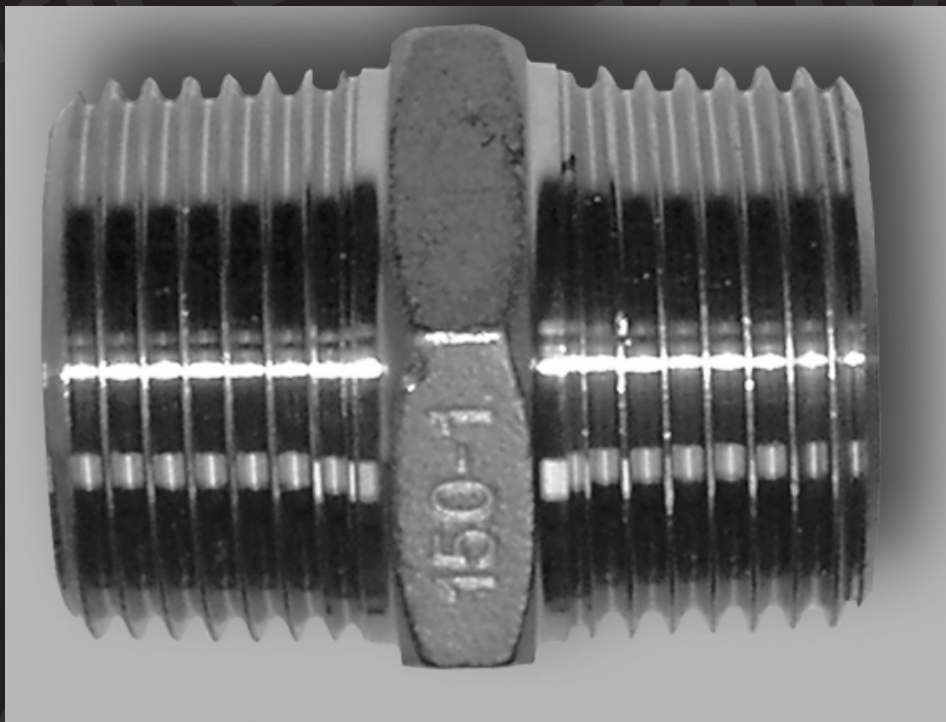

Side	Sidens innhold
2	Indeks for denne katalogdel.
3-4	Lavtrykks overganger og nipler i AISI 316, messing og galvanisert adusergods.
5-6	Messing rørfittings serie 60
7-10	Hurtigkupper for pneumatikk. Messingkropp.
11	Hurtigkupper for pneumatikk. Banjoskruer og rørkutter.
12	Polyamid og polyuretanrør.









**På vår internettside finner du alltid de siste nyhetene om våre produkter, og oppdatert produktkatalog.**

**BESØK OSS PÅ: [WWW.ACTIVE-SERVICE.NO](http://WWW.ACTIVE-SERVICE.NO)**

For syrefast, legg til SS bak varenr.

For messing, legg til BR bak varenr.









Andre dimensjoner, typer og materialkvaliteter på forespørsel.

									
Gjenge 1 BSP	Gjenge 2 BSP	Ansats Nippel Utv. gjenger Varenr.	Ans. overg. Nippel Utv. gjenger Varenr.	Muffe Innv. gjenger Varenr.	Overgangs muffe Innv. gjenger Varenr.	Reduksjon Utv. / innv. gjenger Varenr.	T-rør Innv. / innv. gjenger Varenr.	90° Albue Innv. / innv. gjenger Varenr.	90° Albue Utv. / innv. gjenger Varenr.
1/8	1/8	280-0202		270-0202			130-0202	90-0202	
1/8	1/4		245-0204		240-0204	241-0402			
1/8	3/8		245-0206		240-0206	241-0602			
1/8	1/2		245-0208		240-0208	241-0802			
1/4	1/4	280-0404		270-0404			130-0404	90-0404	92-0404
1/4	3/8		245-0406		240-0406	241-0604	130-0406	90-0406	
1/4	1/2		245-0408		240-0408	241-0804	130-0408	90-0408	
1/4	3/4		245-0412		240-0412	241-1204	130-0412		
3/8	3/8	280-0606		270-0606			130-0606	90-0606	92-0606
3/8	1/2		245-0608		240-0608	241-0806	130-0608	90-0608	
3/8	3/4		245-0612		240-0612	241-1206	130-0612	90-0612	
3/8	1		245-0616		240-0616	241-1606	130-0616	90-0616	
1/2	1/2	280-0808		270-0808			130-0808	90-0808	92-0808
1/2	3/4		245-0812		240-0812	241-1208	130-0812	90-0812	
1/2	1		245-0816		240-0816	241-1608	130-0816	90-0816	
1/2	1.1/4		245-0820		240-0820	241-2008	130-0820	90-0820	
3/4	3/4	280-1212		270-1212			130-1212	90-1212	92-1212
3/4	1		245-1216		240-1216	241-1612	130-1216	90-1216	
3/4	1.1/4		245-1220		240-1220	241-2012	130-1220	90-1220	
3/4	1.1/2		245-1224		240-1224	241-2412	130-1224		
1	1	280-1616		270-1616			130-1616	90-1616	92-1616
1	1.1/4		245-1620		240-1620	241-2016	130-1620	90-1620	
1	1.1/2		245-1624		240-1624	241-2416	130-1624	90-1624	
1	2		245-1632		240-1632	241-3216	130-1632	90-1632	
1.1/4	1.1/4	280-2020		270-2020			130-2020	90-2020	92-2020
1.1/4	1.1/2		245-2024		240-2024	241-2420	130-2024	90-2024	
1.1/4	2		245-2032		240-2032	241-3220	130-2032	90-2032	
1.1/4	2.1/2		245-2040		240-2040	241-4020			
1.1/2	1.1/2	280-2424		270-2424			130-2424	90-2424	92-2424
1.1/2	2		245-2432		240-2432	241-3224	130-2432	90-2432	
1.1/2	2.1/2		245-2440		240-2440	241-4024	130-2440	90-2440	
1.1/2	3					241-4824	130-2448		
2	2	280-3232		270-3232			130-3232	90-3232	92-3232
2	2.1/2		245-3240		240-3240	241-4032	130-3240	90-3240	
2	3		245-3248		240-3248	241-4832	130-3248		
2	4		245-3264			241-6432			
2.1/2	2.1/2	280-4040		270-4040			130-4040	90-4040	92-4040
2.1/2	3		245-4048		240-4048	241-4840	130-4048	90-4048	
2.1/2	4								
3	3	280-4848		270-4848			130-4848	90-4848	92-4848
3	4		245-4864		240-4864	241-6448			
4	4	280-6464		270-6464			130-6464	90-6464	92-6464

For syrefast, legg til SS bak varenr.

For messing, legg til BR bak varenr.

Andre dimensjoner, typer og materialkvaliteter på forespørsel.

								
Gjenge	Plugg Utv. gjenge	Hette Innv. gjenger	Kryss Innv. gjenger	Y-rør Innv. gjenger	45° Albue Innv. / innv. gjenger	Låsemutter Innv. gjenge	Union Innv. / innv. gjenger	Tipp Union Utv. / innv. gjenger
BSP	Varenr.	Varenr.	Varenr.	Varenr.	Varenr.	Varenr.	Varenr.	Varenr.
1/8	290-02	300-02	180-02	132-02	120-0202	310-02	340-02	341-02
1/4	290-04	300-04	180-04	132-04	120-0404	310-04	340-04	341-04
3/8	290-06	300-06	180-06	132-06	120-0606	310-06	340-06	341-06
1/2	290-08	300-08	180-08	132-08	120-0808	310-08	340-08	341-08
3/4	290-12	300-12	180-12	132-12	120-1212	310-12	340-12	341-12
1	290-16	300-16	180-16	132-16	120-1616	310-16	340-16	341-16
1.1/4	290-20	300-20	180-20	132-20	120-2020	310-20	340-20	341-20
1.1/2	290-24	300-24	180-24	132-24	120-2424	310-24	340-24	341-24
2	290-32	300-32	180-32	132-32	120-3232	310-32	340-32	341-32
2.1/2	290-40	300-40	180-40	132-40	120-4040	310-40		
3	290-48	300-48	180-48	132-48	120-4848	310-48		
4	290-64	300-64	180-64	132-64	120-6464	310-64	340-64	

## Kobberrør

Rør MM	Varenr.
3	1786-03
4	1786-04
5	1786-05
6	1786-06
8	1786-08
10	1786-10
12	1786-12
15	1786-15
16	1786-16
18	1786-18
20	1786-20
22	1786-22

## Messingfittings





Brukes sammen med: Kobber-, messing-, aluminium- og plastrør.  
Anbefales ikke for stålrør. Til myke plastrør brukes innvendig støttehylse.





**Arb. trykk:** Opp til 130 bar på 3 - 6mm.  
Opp til 65 bar på 8 - 12mm.  
Opp til 50 bar på 15 - 22mm.

**Temp. grenser:** -55°C til + 120°C.

**Typiske bruksomr.:** Olje, luft, vann og gass.

**Ordreinformasjon:** Bestilles komplett (kropp, mutter og konus).  
Fittingen leveres slik illustrasjonen viser.

Rør MM							
	Støttehylse	Konus	Mutter	Union	T-rør	Albu	Kryss
3	59F-03MM	60F-03MM	61F-03MM	62F-03MM	64F-03MM	65F-03MM	
4	59F-04MM	60F-04MM	61F-04MM	62F-04MM	64F-04MM	65F-04MM	
5	59F-05MM	60F-05MM	61F-05MM	62F-05MM	64F-05MM	65F-05MM	78F-05MM
6	59F-06MM	60F-06MM	61F-06MM	62F-06MM	64F-06MM	65F-06MM	78F-06MM
8	59F-08MM	60F-08MM	61F-08MM	62F-08MM	64F-08MM	65F-08MM	78F-08MM
10	59F-10MM	60F-10MM	61F-10MM	62F-10MM	64F-10MM	65F-10MM	
12	59F-12MM	60F-12MM	61F-12MM	62F-12MM	64F-12MM	65F-12MM	78F-12MM
15	59F-15MM	60F-15MM	61F-15MM	62F-15MM	64F-15MM	65F-15MM	78F-15MM
16	59F-16MM	60F-16MM	61F-16MM	62F-16MM	64F-16MM	65F-16MM	78F-16MM
18	59F-18MM	60F-18MM	61F-18MM	62F-18MM	64F-18MM	65F-18MM	78F-18MM
20	59F-20MM	60F-20MM	61F-20MM	62F-20MM	64F-20MM	65F-20MM	78F-20MM
22	59F-22MM	60F-22MM	61F-22MM	62F-22MM	64F-22MM	65F-22MM	78F-22MM

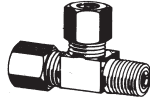
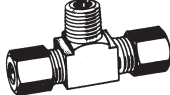
Rør MM	Gjenge BSP						
		Nippel- muffe	Tipp- union	Albu- tipp	Albu- muffe	T-rør	T-rør
3	1/8	66F-03MM02	68F-03MM02	69F-03MM02	70F-03MM02	71F-03MM02	72F-03MM02
4	1/8	66F-04MM02	68F-04MM02	69F-04MM02	70F-04MM02	71F-04MM02	72F-04MM02
5	1/8	66F-05MM02	68F-05MM02	69F-05MM02	70F-05MM02	71F-05MM02	72F-05MM02
5	1/4	66F-05MM04	68F-05MM04	69F-05MM04	70F-05MM04	71F-05MM04	72F-05MM04
6	1/8	66F-06MM02	68F-06MM02	69F-06MM02	70F-06MM02	71F-06MM02	72F-06MM02
6	1/4	66F-06MM04	68F-06MM04	69F-06MM04	70F-06MM04	71F-06MM04	72F-06MM04
6	3/8	66F-06MM06	68F-06MM06	69F-06MM06	70F-06MM06	71F-06MM06	72F-06MM06
6	1/2	66F-06MM08	68F-06MM08	69F-06MM08	70F-06MM08	71F-06MM08	72F-06MM08
8	1/8	66F-08MM02	68F-08MM02	69F-08MM02	70F-08MM02	71F-08MM02	72F-08MM02
8	1/4	66F-08MM04	68F-08MM04	69F-08MM04	70F-08MM04	71F-08MM04	72F-08MM04
8	3/8	66F-08MM06	68F-08MM06	69F-08MM06	70F-08MM06	71F-08MM06	72F-08MM06
8	1/2	66F-08MM08	68F-08MM08	69F-08MM08	70F-08MM08	71F-08MM08	72F-08MM08
10	1/8	66F-10MM02	68F-10MM02	69F-10MM02	70F-10MM02	71F-10MM02	72F-10MM02
10	1/4	66F-10MM04	68F-10MM04	69F-10MM04	70F-10MM04	71F-10MM04	72F-10MM04
10	3/8	66F-01MM06	68F-01MM06	69F-01MM06	70F-01MM06	71F-01MM06	72F-01MM06
10	1/2	66F-10MM08	68F-10MM08	69F-10MM08	70F-10MM08	71F-10MM08	72F-10MM08
12	1/4	66F-12MM04	68F-12MM04	69F-12MM04	70F-12MM04	71F-12MM04	72F-12MM04
12	3/8	66F-12MM06	68F-12MM06	69F-12MM06	70F-12MM06	71F-12MM06	72F-12MM06
12	1/2	66F-12MM08	68F-12MM08	69F-12MM08	70F-12MM08	71F-12MM08	72F-12MM08
12	3/4	66F-12MM12	68F-12MM12	69F-12MM12	70F-12MM12	71F-12MM12	72F-12MM12
15	1/4	66F-15MM04	68F-15MM04	69F-15MM04	70F-15MM04	71F-15MM04	72F-15MM04
15	3/8	66F-15MM06	68F-15MM06	69F-15MM06	70F-15MM06	71F-15MM06	72F-15MM06
15	1/2	66F-15MM08	68F-15MM08	69F-15MM08	70F-15MM08	71F-15MM08	72F-15MM08
15	3/4	66F-15MM12	68F-15MM12	69F-15MM12	70F-15MM12	71F-15MM12	72F-15MM12
16	1/4	66F-16MM04	68F-16MM04	69F-16MM04	70F-16MM04	71F-16MM04	72F-16MM04
16	3/8	66F-16MM06	68F-16MM06	69F-16MM06	70F-16MM06	71F-16MM06	72F-16MM06
16	1/2	66F-16MM08	68F-16MM08	69F-16MM08	70F-16MM08	71F-16MM08	72F-16MM08
16	3/4	66F-16MM12	68F-16MM12	69F-16MM12	70F-16MM12	71F-16MM12	72F-16MM12
18	3/8	66F-18MM06	68F-18MM06	69F-18MM06	70F-18MM06	71F-18MM06	72F-18MM06
18	1/2	66F-18MM08	68F-18MM08	69F-18MM08	70F-18MM08	71F-18MM08	72F-18MM08
18	3/4	66F-18MM12	68F-18MM12	69F-18MM12	70F-18MM12	71F-18MM12	72F-18MM12
20	3/4	66F-20MM12	68F-20MM12	69F-20MM12	70F-20MM12	71F-20MM12	72F-20MM12
22	3/4	66F-22MM12	68F-22MM12	69F-22MM12	70F-22MM12	71F-22MM12	72F-22MM12
22	1	66F-22MM16	68F-22MM16	69F-22MM16	70F-22MM16	71F-22MM16	72F-22MM16

Prestolok er en kupling beregnet for montering av nylonrør for pneumatikk. Kuplingen er av innstikk typen og produseres i forniklet messing, og for å gjøre monteringen enkel har Prestolok O-ring på alle parallelle gjenger, og et teflonbelegg (PTFE) på alle koniske gjenger.

Ved montering kuttes røret rett med en rørkutter. Deretter stikkes rørenden inn i kuplingen til røret bunner i kuplingskroppen. Røret vil da automatisk bli holdt fast av holderingen. Ved demontering frigjøres røret med et lett trykk på utløserhylsen i kuplingens forkant.

Prestolok har en spesiell holdering som ikke lager merker i røret, og ringens elastisitet absorberer vibrasjoner og pulsering. En unik støttering beskytter o-ring og holder den på plass. Dette gir sikker tetning og forhindrer utpressing av røret ved høye trykk.

Se også vårt program for prestolok 2.

Andre spesialkomponenter som kuplinger med integrerte styringsfunksjoner for direkte montering på sylindere finnes også.

Se våre hjemmesider på [www.active-service.no](http://www.active-service.no) for utfyllende informasjon og mål.

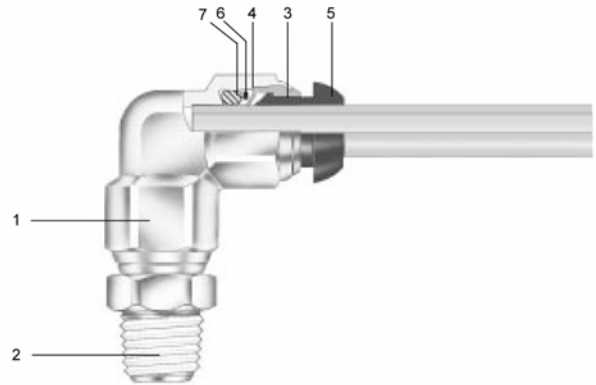

Materiale							Arbeids trykk	Arbeids temperatur
1	2	3	4	5	6	7		
Kropp	Gjengeparti	Hylse	Holdering	Trykk ring	Skive	O-ring	Fra 0.01 bar til 25 bar	Fra -25°C til +100°C
Forniklet messing	Forniklet messing	Messing	Syrefast stål	Polyacetal	Messing	Nitril		

### Bruksområder

Prestolok er utviklet for å tåle en rekke væsker i tillegg til trykkluft. Prestolok er en "push-in" fitting som er spesielt egnet for bruk i tøffe omgivelser.

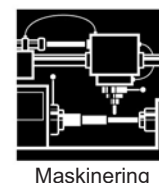
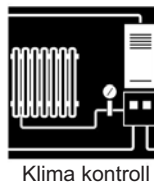

## Prestolok

Kompakt - klar til bruk fitting  
Stort utvalg  
Full gjennomstrømning



### Kropp i forniklet messing

Messing er et materiale som gir fordeler som:

- meget robust utførelse
  - utmerket sjokk egenskaper
  - gode temperatur egenskaper
- fornikling gir god motstand mot korrosjon.

### Brukes med plast eller metallrør

Prestolok er en høykvalitets "push in" fitting som kan brukes med de fleste typer plastrør (polyamid, poluretan, polyetylen, Pebax, Teflon® etc.) Kan også brukes med kobberør iht. DIN 1786, NFA51-120, BS 2871 (toleranse +/-0,05mm)

### Fleksibel syrefast låsering for optimalt grep

- den spesielle holderingen lager ikke merke på røret
- elastisiteten i holderingen tar opp vibrasjoner og pulsering
- røret roterer fritt under trykk og en unngår vridninger

14



### Klar til bruk fitting

Prestolok leveres klar til bruk

- o-rings tetning på parallelle gjenger
- PTFE tetning på koniske gjenger.



PTFE tetningen kan brukes om igjen opp til 5 ganger uten bruk av ytterligere tetningsstoff.

### Rette kuplinger med innvendig sekskant

Innvendig sekskant for unbrako for mindre byggemål og lettere montering der det er trangt.

### Plastik trykkring

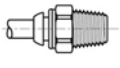
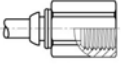
Enkel manuell og brukervenlig trykkring sikrer enkel demontering Rørdimensjon er merket på trykkringen.

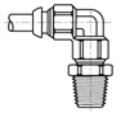
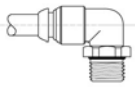
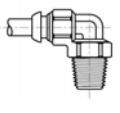
Arbeidstrykk Fra 0.01-25 bar								
Arbeidstemp. -25°C til +100°C		<b>Rett Innskruing</b>	<b>Rett Innskruing</b>	<b>Rett Påskruing</b>	<b>Albu 90° Justerbar</b>	<b>Albu 90° Justerbar</b>	<b>Kompakt Albu 90° Justerbar</b>	<b>Kompakt Albu 90°</b>
Rør MM	Gjenge BSP	<b>BSPP</b>	<b>BSPT</b>	<b>BSPP</b>	<b>BSPP</b>	<b>BSPT</b>	<b>BSPP</b>	<b>BSPT</b>
4	1/8	F4PB-0402	F3PB-0402	G4PB-0402	C64PB-0402	C63PB-0402	C64SPB-0402	C3PB-0402
4	1/4	F4PB-0404	F3PB-0404		C64PB-0404	C63PB-0404		
6	1/8	F4PB-0602	F3PB-0602	G4PB-0602	C64PB-0602	C63PB-0602	C64SPB-0602	C3PB-0602
6	1/4	F4PB-0604	F3PB-0604	G4PB-0604	C64PB-0604	C63PB-0604	C64SPB-0604	C3PB-0604
8	1/8	F4PB-0802	F3PB-0802	G4PB-0802	C64PB-0802	C63PB-0802	C64SPB-0802	C3PB-0802
8	1/4	F4PB-0804	F3PB-0804	G4PB-0804	C64PB-0804	C63PB-0804	C64SPB-0804	C3PB-0804
8	3/8	F4PB-0806	F3PB-0806		C64PB-0806	C63PB-0806	C64SPB-0806	
10	1/4	F4PB-1004	F3PB-1004		C64PB-1004	C63PB-1004	C64SPB-1004	C3PB-1004
10	3/8	F4PB-1006	F3PB-1006		C64PB-1006	C63PB-1006	C64SPB-1006	C3PB-1006
10	1/2	F4PB-1008	F3PB-1008					
12	1/4	F4PB-1204	F3PB-1204		C64PB-1204	C63PB-1204	C64SPB-1204	
12	3/8	F4PB-1206	F3PB-1206		C64PB-1206	C63PB-1206	C64SPB-1206	C3PB-1206
12	1/2	F4PB-1208	F3PB-1208			C63PB-1208	C64SPB-1208	C3PB-1208
14	3/8	F4PB-1406	F3PB-1406		C64PB-1406	C63PB-1406		C3PB-1406
14	1/2	F4PB-1408	F3PB-1408		C64PB-1408	C63PB-1408		C3PB-1408

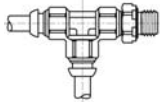
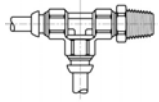
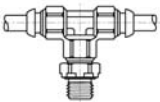
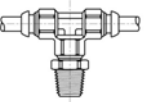
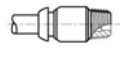
Arbeidstrykk Fra 0.01-25 bar						
Arbeidstemp. -25°C til +100°C		<b>T Justerbar</b>	<b>T Justerbar</b>	<b>T Justerbar</b>	<b>T Justerbar</b>	<b>Rett Innskr. m/innv. Umbrako</b>
Rør MM	Gjenge BSP	<b>BSPP</b>	<b>BSPT</b>	<b>BSPP</b>	<b>BSPT</b>	<b>BSPT</b>
4	1/8	R64PB-0402	R63PB-0402	S64PB-0402	S63PB-0402	F23PB-0402
4	1/4	R64PB-0404	R63PB-0404	S64PB-0404	S63PB-0404	
6	1/8	R64PB-0602	R63PB-0602	S64PB-0602	S63PB-0602	F23PB-0602
6	1/4	R64PB-0604	R63PB-0604	S64PB-0604	S63PB-0604	F23PB-0604
8	1/8	R64PB-0802	R63PB-0802	S64PB-0802	S63PB-0802	F23PB-0802
8	1/4	R64PB-0804	R63PB-0804	S64PB-0804	S63PB-0804	F23PB-0804
8	3/8	R64PB-0806	R63PB-0806	S64PB-0806	S63PB-0806	
10	1/4	R64PB-1004	R63PB-1004	S64PB-1004	S63PB-1004	
10	3/8	R64PB-1006	R63PB-1006	S64PB-1006	S63PB-1006	
10	1/2					
12	1/4	R64PB-1204	R63PB-1204	S64PB-1204	S63PB-1204	
12	3/8	R64PB-1206	R63PB-1206	S64PB-1206	S63PB-1206	
12	1/2		R63PB-1208		S63PB-1208	
14	3/8	R64PB-1406	R63PB-1406	S64PB-1406	S63PB-1406	
14	1/2	R64PB-1408	R63PB-1408	S64PB-1408	S63PB-1408	

For mer informasjon, se vår hjemmeside [www.active-service.no/katalog/prestelok.pdf](http://www.active-service.no/katalog/prestelok.pdf)

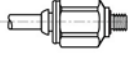
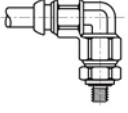
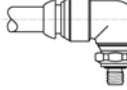
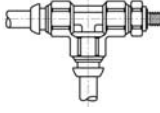
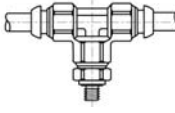
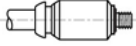
Arbeidstrykk Fra 0.01-25 bar							
Arbeidstemp. -25°C til +100°C		<b>Rett Innskruing</b>	<b>Albu 90° Justerbar</b>	<b>Kompakt Albu 90° Justerbar</b>	<b>T Justerbar</b>	<b>T Justerbar</b>	<b>Rett Innskr. m/innv. Umbrako</b>
Rør MM	Gjenge Metrisk	<b>Metrisk</b>	<b>Metrisk</b>	<b>Metrisk</b>	<b>Metrisk</b>	<b>Metrisk</b>	<b>Metrisk</b>
4	M3x0,5		C68PB-0403		R68PB-0403	S68PB-0403	F28PB-0403
4	M5x0,8	F8PB-0405	C68PB-0405	C68SPB-0405	R68PB-0405	S68PB-0405	F28PB-0405
4	M10x1,0	F8PB-0410					
6	M5x0,8	F8PB-0605	C68PB-0605	C68SPB-0605	R68PB-0605	S68PB-0605	F28PB-0605
6	M10x1,0	F8PB-0610					
6	M12x1,5	F8PB-0612					
8	M12x1,5	F8PB-0812					
8	M16x1,5	F8PB-0816					
8	M22x1,5	F8PB-0822					

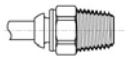
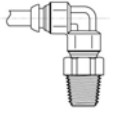
Arbeidstrykk Fra 0.01-25 bar			
Arbeidstemp. Fra -25°C til +100°C		<b>Rett Innskruing</b>	<b>Albu 90° Justerbar</b>
Rør MM	Gjenge BSP/NPT	<b>NPTF</b>	<b>NPTF</b>
4	1/8	WG4PB-0402	
6	1/8	WG4PB-0602	FPB-0602
6	1/4	WG4PB-0604	FPB-0604
6	3/8		C6PB-0606
8	1/8	WG4PB-0802	
8	1/4	WG4PB-0804	
10	1/4		FPB-1004
10	3/8	WG4PB-1006	FPB-1006
12	3/8	WG4PB-1206	FPB-1206
12	1/2	WG4PB-1208	C6PB-1208

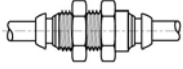
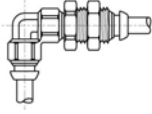

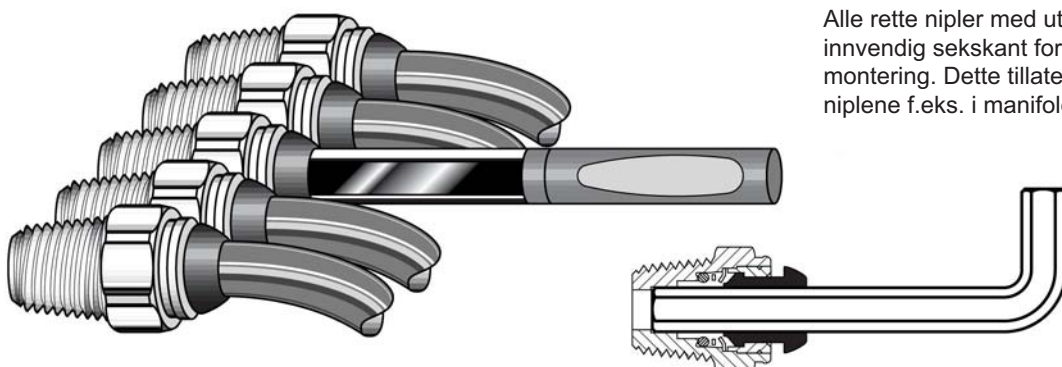

Arbeidstrykk Fra 0.01-25 bar			
Arbeidstemp. Fra -25°C til +100°C		<b>Rett Skott- gjennomf.</b>	<b>Albu 90° Skott- gjennomf.</b>
Rør MM		<b>BSP</b>	<b>NPTF</b>
4		WPB-04	WE6PB-04
6		WPB-06	WE6PB-06
8		WPB-08	WE6PB-08
10		WPB-10	WE6PB-10
12		WPB-12	WE6PB-12
14		WPB-14	



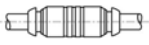

14

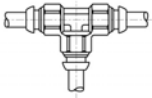

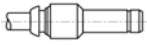
Alle rette nipler med utvendige gjenger har innvendig sekskant for umbrako for enklere montering. Dette tillater tettere montering av niplene f.eks. i manifolder og rekker.

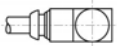
For mer informasjon, se vår hjemmeside [www.active-service.no/katalog/prestolok.pdf](http://www.active-service.no/katalog/prestolok.pdf)

Arbeidstrykk Fra 0.01-25 bar						
Arbeidstemp. -25°C til +100°C		<b>Rett Skjøt</b>	<b>Albu 90° Skjøt</b>	<b>T Skjøt</b>	<b>Plugg</b>	<b>Reduksjon</b>
Rør 1 MM	Rør 2 MM					
4	4	HPB-04	EPB-04	JPB-04	FNPB-04	
4	6					TRPB-0406
4	8					TRPB-0408
6	6	HPB-06	EPB-06	JPB-06	FNPB-06	
6	8					TRPB-0608
6	10					TRPB-0610
6	12					TRPB-0612
8	8	HPB-08	EPB-08	JPB-08	FNPB-08	
8	10					TRPB-0810
8	12					TRPB-0812
8	14					TRPB-0814
10	10	HPB-10	EPB-10	JPB-10	FNPB-10	
10	12					TRPB-1012
10	14					TRPB-1014
12	12	HPB-12	EPB-12	JPB-12	FNPB-12	
12	14					TRPB-1214
14	14	HPB-14	EPB-14	JPB-14	FNPB-14	

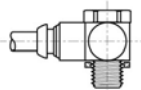
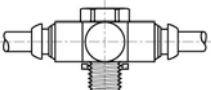
Arbeidstrykk Fra 0.01-25 bar							
Arbeidstemp. -25°C til +100°C		<b>Enkel Banjo Kropp</b>	<b>Dobbel Banjo Kropp</b>	<b>Banjo Bolt m/pakn.</b>	<b>Banjo Bolt m/pakning for oppbyggn.</b>	<b>Enkel Banjo Komplet</b>	<b>Dobbel Banjo Komplet</b>
Rør MM	Gjenge BSP/MM						
4	M5x0,8	CORPB-0405	CORPBD-0405	SC8UM-0405	SC8UDM-0405	COR8PB-0405	COR8PBD-0405
4	1/8	CORPB-0402	CORPBD-0402	SC4U-0402*	SC4UD-0402*	COR4PB-0402	COR4PBD-0402
6	M10x1,0					COR8PB-0610	COR8PBD-0610
6	M12x1,5					COR8PB-0612	COR8PBD-0612
6	1/8	CORPB-0602	CORPBD-0602	SC4U-0402*	SC4UD-0402*	COR4PB-0602	COR4PBD-0602
6	1/4	CORPB-0604	CORPBD-0604	SC4U-0604*	SC4UD-0604*	COR4PB-0604	COR4PBD-0604
8	1/8	CORPB-0802	CORPBD-0802	SC4U-0802	SC4UD-0802	COR4PB-0802	COR4PBD-0802
8	1/4	CORPB-0804		SC4U-0604*	SC4UD-0604*	COR4PB-0804	COR4PBD-0804
10	3/8	CORPB-1006		SC4U-1006	SC4UD-1006	COR4PB-1006	

\* Dekker flere dimensjoner

Rør MM	Polyamid Nøytral	Polyamid Rød	Polyamid Blå	Polyamid Grønn	Polyamid Sort	Polyamid Brun	Polyamid Gul	Polyamid Orange	Polyamid Grå	Polyamid Purpur	Polyamid Rosa	Polyamid Hvit	Polyamid Sølv
4	PA1-04	PA2-04	PA3-04	PA4-04	PA5-04	PA6-04	PA7-04	PA8-04	PA9-04	PA10-04	PA11-04	PA12-04	PA13-04
6	PA1-06	PA2-06	PA3-06	PA4-06	PA5-06	PA6-06	PA7-06	PA8-06	PA9-06	PA10-06	PA11-06	PA12-06	PA13-06
8	PA1-08	PA2-08	PA3-08	PA4-08	PA5-08	PA6-08	PA7-08	PA8-08	PA9-08	PA10-08	PA11-08	PA12-08	PA13-08
10	PA1-10	PA2-10	PA3-10	PA4-10	PA5-10	PA6-10	PA7-10	PA8-10	PA9-10	PA10-10	PA11-10	PA12-10	PA13-10
12	PA1-12	PA2-12	PA3-12	PA4-12	PA5-12	PA6-12	PA7-12	PA8-12	PA9-12	PA10-12	PA11-12	PA12-12	PA13-12
14	PA1-14	PA2-14	PA3-14	PA4-14	PA5-14	PA6-14	PA7-14	PA8-14	PA9-14	PA10-14	PA11-14	PA12-14	PA13-14

Polyamidrør Arbeidstrykk ved forskjellige temperaturer								
Rør MM	-40	-20	0	+20	+30	+40	+50	+60
4x1,0	44	44	44	44	33	33	25	25
6x1,0	27	27	27	27	20	20	15	15
8x1,0	19	19	19	19	14	14	11	11
10x1,0	15	15	15	15	11	11	8	8
12x1,0	12	12	12	12	9	9	7	7
14x1,5	16	16	16	16	12	12	9	9

Polyamidrør Bøyeradius	
Rør MM	R MM
4x1	20
6x1	35
8x1	45
10x1	60
12x1	70
14x1,5	85

Kompabilitet Væske	Arbeidstemp.°C		
	-20	+20	+60
Maskineringsolje	A	A	A
Maskineringsvæsker	A	A	A
Vann	A	A	A
Hydraulikkolje	A	A	A
Mineralolje / Grease	A	A	A
Karbondioksid	A	A	A
Aceton	A	A	A
Bensin	B	B	B
Trikloretylen	-	C	C

Polyamidrør som tilfredsstillers DIN73378, BS5409 PT1, og CETOP RP54P

**Sikkerhetsfaktor 3:1**

A=utmerket, B=egnet, C=lite egnet  
kontakt oss for andre væsker

MM	Polyuretan Nøytral	Polyuretan Rød	Polyuretan Blå	Polyuretan Grønn	Polyuretan Sort	Polyuretan Brun	Polyuretan Gul	Polyuretan Orange	Polyuretan Grå	Polyuretan Purpur	Polyuretan Rosa	Polyuretan Hvit	Polyuretan Sølv
4	PU1-04	PU2-04	PU3-04	PU4-04	PU5-04	PU6-04	PU7-04	PU8-04	PU9-04	PU10-04	PU11-04	PU12-04	PU13-04
6	PU1-06	PU2-06	PU3-06	PU4-06	PU5-06	PU6-06	PU7-06	PU8-06	PU9-06	PU10-06	PU11-06	PU12-06	PU13-06
8	PU1-08	PU2-08	PU3-08	PU4-08	PU5-08	PU6-08	PU7-08	PU8-08	PU9-08	PU10-08	PU11-08	PU12-08	PU13-08
10	PU1-10	PU2-10	PU3-10	PU4-10	PU5-10	PU6-10	PU7-10	PU8-10	PU9-10	PU10-10	PU11-10	PU12-10	PU13-10
12	PU1-12	PU2-12	PU3-12	PU4-12	PU5-12	PU6-12	PU7-12	PU8-12	PU9-12	PU10-12	PU11-12	PU12-12	PU13-12

Polyamidrør Arbeidstrykk ved forskjellige temperaturer								
Rør MM	-35	-20	0	+20	+30	+40	+50	+60
4x0,75	14	14	14	14	11	11	9	9
6x1,0	12	12	12	12	9	9	8	8
8x1,25	11	11	11	11	9	9	8	8
10x1,5	10	10	10	10	8	8	7	7
12x2,0	12	12	12	12	9	9	8	8

Polyamidrør Bøyeradius	
Rør MM	R MM
4x1	17
6x1	27
8x1	37
10x1	54
12x1	62

Kompabilitet Væske	Arbeidstemp.°C		
	-20	+20	+60
Maskineringsolje	A	A	A
Maskineringsvæsker	A	A	A
Vann	A	A	A
Hydraulikkolje	A	A	A
Mineralolje / Grease	A	A	A
Karbondioksid	A	A	A
Aceton	B	B	B
Bensin	-	C	C
Trikloretylen	-	C	C

Polyuretanrør som tilfredsstillers NF E49 - 101 1994

**Sikkerhetsfaktor 3:1**

A=utmerket, B=egnet, C=lite egnet  
kontakt oss for andre væsker

For mer informasjon, se vår hjemmeside [www.active-service.no/katalog/plastror.pdf](http://www.active-service.no/katalog/plastror.pdf)